

Tags on Sheets

Easy to use!
Just peel and stick to your package.

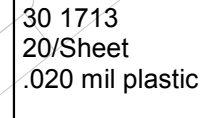
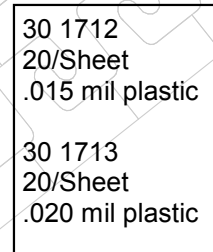
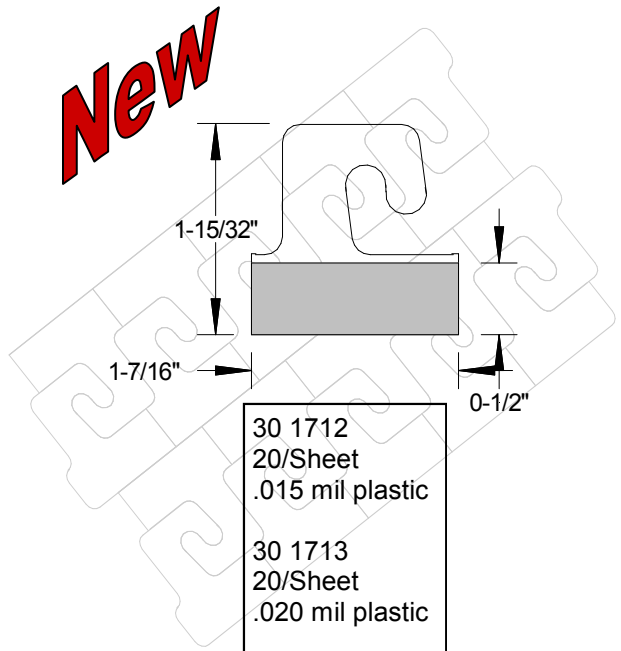
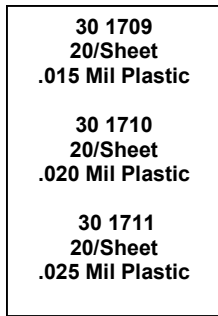
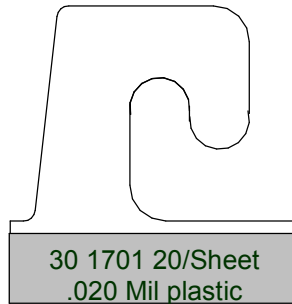
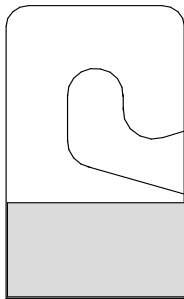
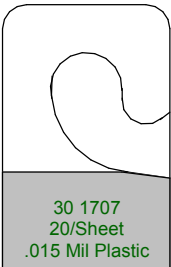
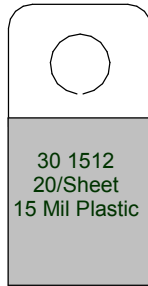
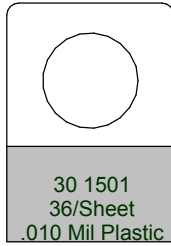
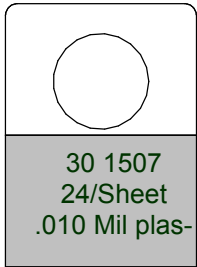
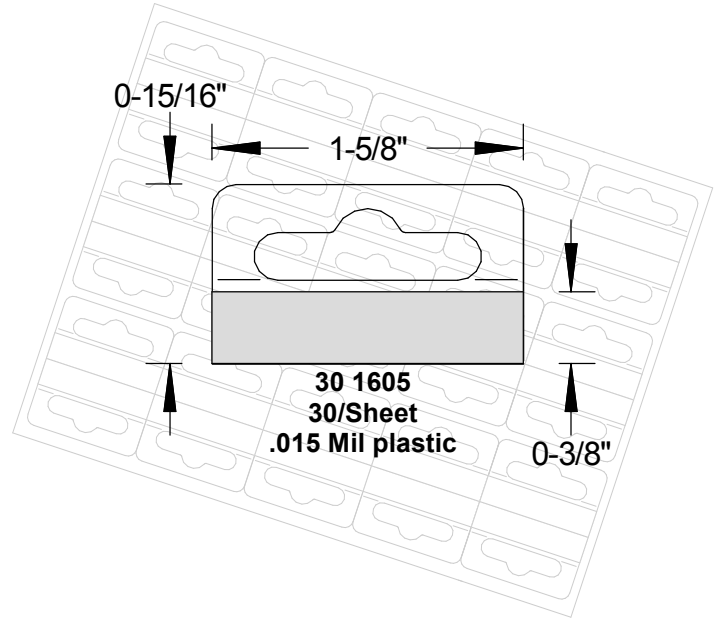
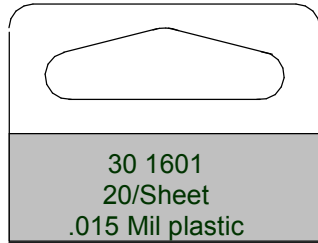
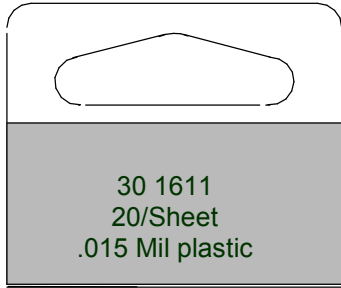
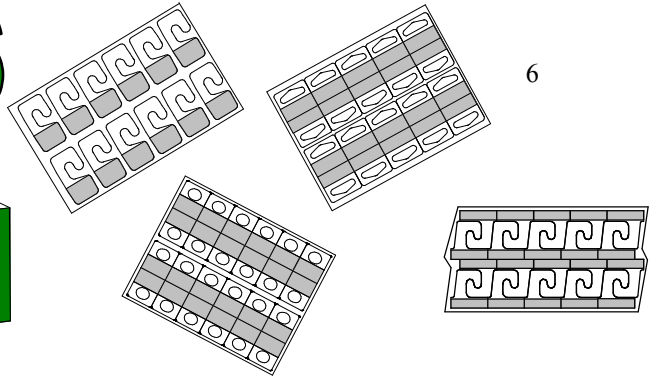
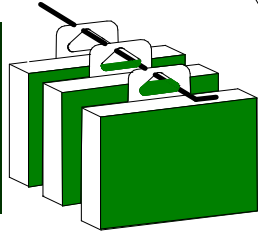

Tower Tag products protected under US patent number: 6,840,391